

# M-FORM

---

SPECIFICATION  
PRICE LIST  
FABRICS

[formseating.co.uk](https://formseating.co.uk)



# M-FORM

## SPECIFICATION



## FEATURES OPTIONS BENEFITS WARRANTY

1. Pioneering headrest with adjustable height, angle, and rotation.
2. Paddle controlled back tilt mechanism with 15 lockable positions.
3. Soft-touch armrests with 4D adjustability.
4. Seat with customisable height and depth adjustments.
5. Recline tension control.
6. Polished aluminium base with 60mm castors.
7. Upholstery options available in Mesh, AirFabric, Fabric, or Leather.
8. Adjustable padded lumbar support for enhanced support.
9. Patented dual spring paddle shift mechanism.

The adjustable features of the M-Form are designed to work in harmony, providing comprehensive support for the human body. The chair accommodates a wide range of dynamic movements and postures, with seat height and back tilt easily adjusted via the armrest paddles.



5-Year Warranty

3-Year 3-Shift Warranty

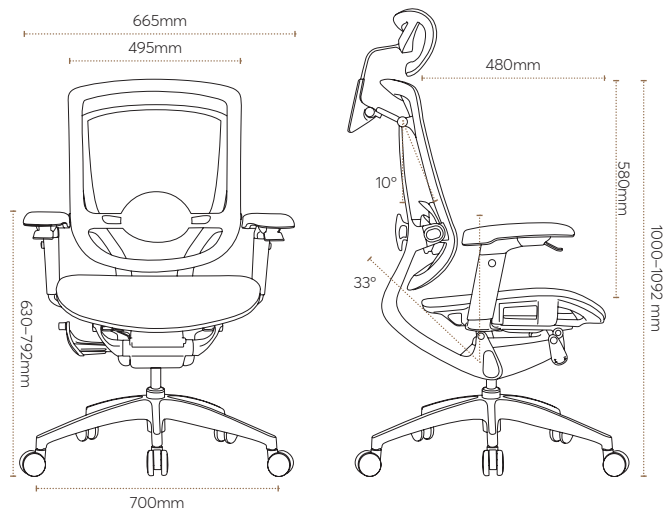

# M-FORM

## PRICE LIST



CODE	M-MMM-PP	M-MMG-PP	M-AAG-PP	M-AAA-PP	M-LLL-PP
Headrest	mesh	mesh	airfabric	airfabric	leather
Back	mesh	mesh	airfabric	airfabric	leather
Seat	mesh	fabric	fabric	airfabric	leather
Polished frame	✓	✓	✓	✓	✓
Polished base	✓	✓	✓	✓	✓

Price	£Price	£Price	£Price	£Price	£Price
-------	--------	--------	--------	--------	--------

Standard Delivery	3-5 Day	Next Day	Saturday	5+ Days
1-10 Units	£Price	POA	£Price	-
11+ Units	Free	POA	POA	-
Part build chair	£Price	-	-	-
Build & train user	-	-	-	£Price
Ireland, Highlands & Islands	£Price	POA	POA	-

All prices per chair.

Other frame colours and seat / back combinations may be available - please contact us for details

All prices quoted ex VAT at current rate. 10 week lead times on non-stock finishes

Orders must be placed by 2pm for next working day delivery.

Please email orders to: [orders@formseating.co.uk](mailto:orders@formseating.co.uk)

# M-FORM BLACK EDITION



## SPECIFICATION



## FEATURES OPTIONS BENEFITS WARRANTY

1. Pioneering headrest with adjustable height, angle, and rotation.
2. Paddle controlled back tilt mechanism with 15 lockable positions.
3. Soft-touch armrests with 4D adjustability.
4. Seat with customisable height and depth adjustments.
5. Recline tension control.
6. Matt Black aluminium base with 60mm castors.
7. Upholstery options available in Mesh, AirFabric, Fabric, or Leather.
8. Adjustable padded lumbar support for enhanced support.
9. Patented dual spring paddle shift mechanism.

The adjustable features of the M-Form are designed to work in harmony, providing comprehensive support for the human body. The chair accommodates a wide range of dynamic movements and postures, with seat height and back tilt easily adjusted via the armrest paddles.



5-Year Warranty

3-Year 3-Shift Warranty

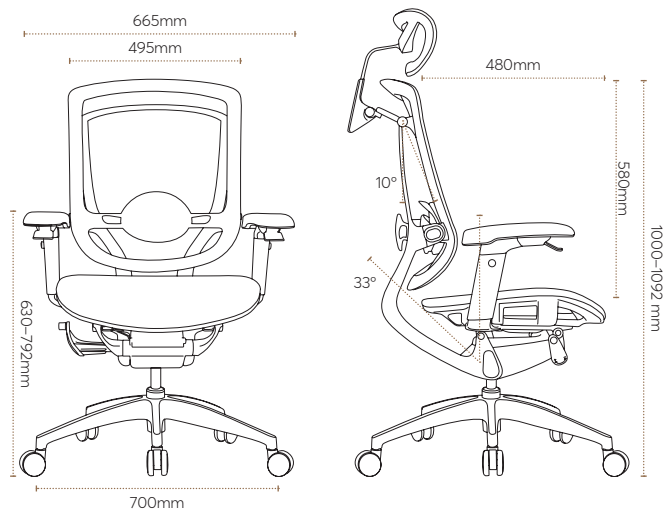

# M-FORM BLACK EDITION



## PRICE LIST



CODE	M-MMM-BB	M-MMG-BB	M-AAG-BB	M-AAA-BB	M-LLL-BB
Headrest	mesh	mesh	airfabric	airfabric	leather
Back	mesh	mesh	airfabric	airfabric	leather
Seat	mesh	fabric	fabric	airfabric	leather
Matt black frame	✓	✓	✓	✓	✓
Matt black base	✓	✓	✓	✓	✓

Price	£Price	£Price	£Price	£Price	£Price
-------	--------	--------	--------	--------	--------

Standard Delivery	3-5 Day	Next Day	Saturday	5+ Days
1-10 Units	£Price	POA	£Price	-
11+ Units	Free	POA	POA	-
Part build chair	£Price	-	-	-
Build & train user	-	-	-	£Price
Ireland, Highlands & Islands	£Price	POA	POA	-

All prices per chair.

Other frame colours and seat / back combinations may be available - please contact us for details  
 All prices quoted ex VAT at current rate. 10 week lead times on non-stock finishes  
 Orders must be placed by 2pm for next working day delivery.

Please email orders to: [orders@formseating.co.uk](mailto:orders@formseating.co.uk)

# FABRICS

## Standard stock



Mesh



Gabriel Medley  
60999



AirFabric



Leather

## Non-stock Gabriel® - Medley

**Gabriel®**



60003

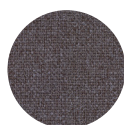

60004



60167



61002



61003



61004



61189

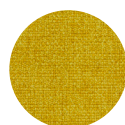

62002

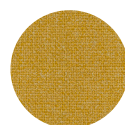

62054



63013

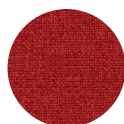

63016

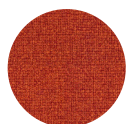

63017



63063



63064

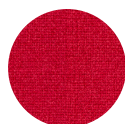

64019

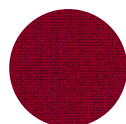

64123

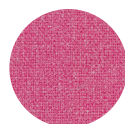

64124



64125

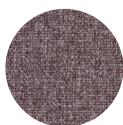

65011

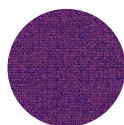

65012



65086

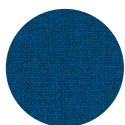

66007

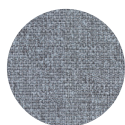

66008

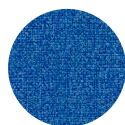

66009

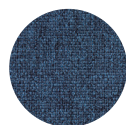

66010

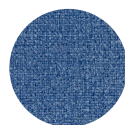

66144

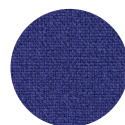

66145

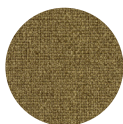

67002

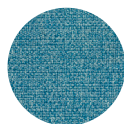

67006



67052

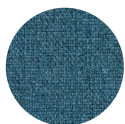

67053

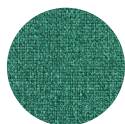

67054

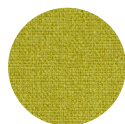

68002

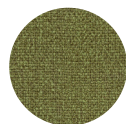

68005



68114

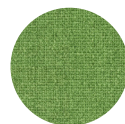

68115

Alternative fabrics and colour swatches may be available on request  
Photographic images are displayed as a guide and colour variations may occur. We advise you request samples before ordering.

Other frame colours and seat / back combinations may be available - please contact us for details  
All prices quoted ex VAT at current rate. 10 week lead times on non-stock finishes  
Orders must be placed by 2pm for next working day delivery.

**Please email orders to: [orders@formseating.co.uk](mailto:orders@formseating.co.uk)**



## CONTACT

---

### Head Office

### Form Seating

Global House  
Adlington Business Park  
Cheshire  
SK10 4NL

### Telephone

(+44) 01625 322 660

### Email

[hello@formseating.co.uk](mailto:hello@formseating.co.uk)

### Web

[formseating.co.uk](http://formseating.co.uk)

**FORM**  
SEATING